

ARTEKALOR

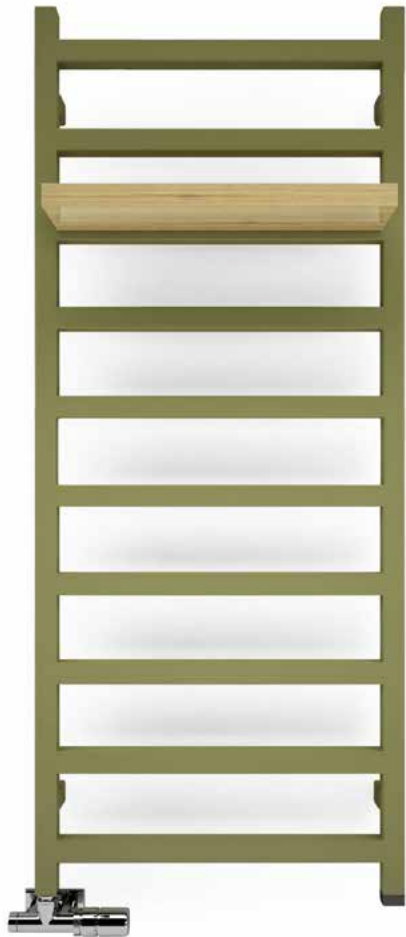

Catalogo Up



4

Up

UP è un radiatore dal design semplice ed essenziale, che si adatta perfettamente ad ogni tipo di ambiente.

L'alternanza di pieni e vuoti ne esalta la funzionalità, permettendo di sfruttare il termo-arredo come scaldia Salviette su tutta la lunghezza.







Up



Materiale	Acciaio
Finitura	Vernice / galvanica
Colori	+250

 ≤1MPa

 MAX 90 °C

Up

Accessori e valvole in tinta con il radiatore disponibili nella gamma colori



Finitura Galvanica:

Riduzione della resa termica fino al 20%.

Tipi di Collegamento



Allacciamenti idraulici fuori standard disponibili a richiesta con Sovrapprezzo.

A	B	C	C1	Δt 50°C	Δt 30°C		D	E	F		
↓	↔	mm	mm	W	W	W	mm	mm	mm	dm ³	Kg
480	500	470	50	173	88	200	470	240	120	2,0	3,7
600	500	470	50	217	111	200	470	360	120	2,5	4,6
720	500	470	50	262	134	300	470	480	120	2,9	5,5
840	500	470	50	306	156	300	470	600	120	3,4	6,3
960	500	470	50	351	179	400	470	720	120	3,9	7,2
1080	500	470	50	396	202	400	470	840	120	4,4	8,1
1200	500	470	50	440	224	400	470	960	120	4,9	8,9
1440	500	470	50	522	266	600	470	1200	120	5,9	10,7
1680	500	470	50	609	311	600	470	1440	120	6,9	12,4
1920	500	470	50	696	355	800	470	1680	120	7,8	14,1

SX

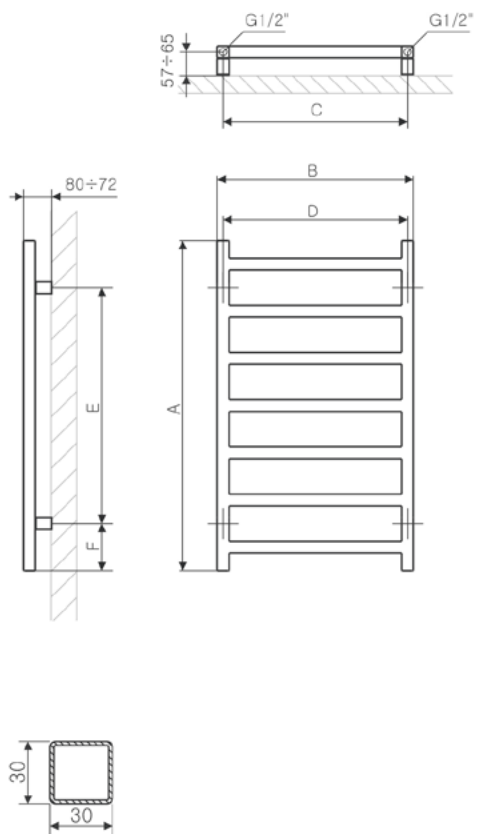

ZX

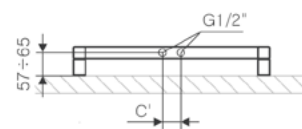

Z1

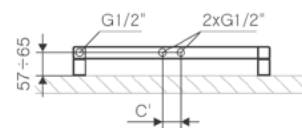

Z8

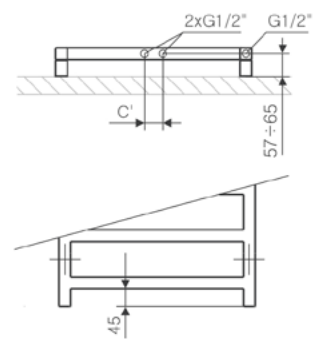

Up DW

Accessori e valvole in tinta con il radiatore disponibili nella gamma colori



Finitura Galvanica:

Riduzione della resa termica fino al 20%.

Tipi di Collegamento



Allacciamenti idraulici fuori standard disponibili a richiesta con Sovrapprezzo.

A	B	C	C1	Δt 50°C	Δt 30°C		D	E	F		
↓	↔	mm	mm	W	W	W	mm	mm	mm	dm ³	Kg
1515	500	40	50	522	266	600	-	1320	15	5,9	10,7
1755	500	40	50	609	311	600	-	1560	15	6,9	12,4
1995	500	40	50	696	355	800	-	1800	15	7,8	14,1

O1

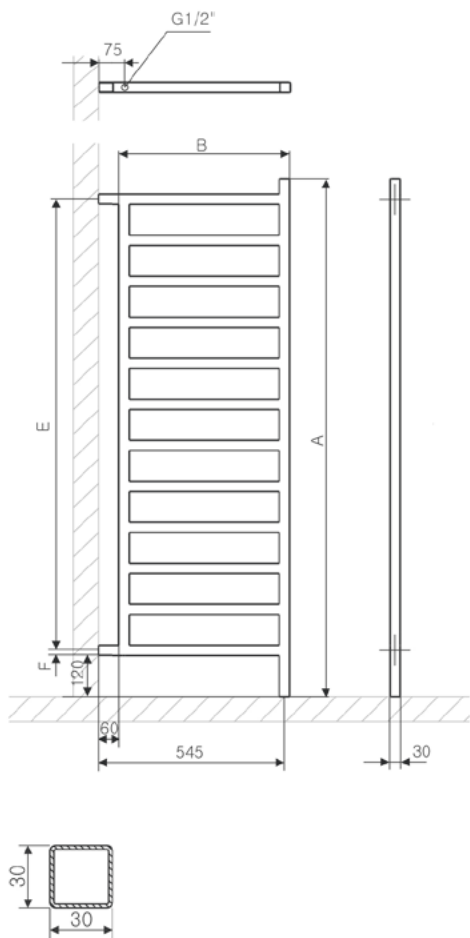

ZX

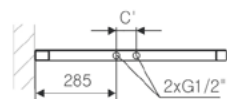

Z1

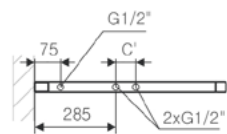

Up one

Accessori e valvole in tinta con il radiatore disponibili nella gamma colori



Finitura Galvanica:

Riduzione della resa termica fino al 20%.

Tipi di Collegamento



Allacciamenti idraulici fuori standard disponibili a richiesta con Sovrapprezzo.

A	B	$\Delta t 50^\circ\text{c}$	$\Delta t 30^\circ\text{c}$		D	E	F		
\updownarrow	\leftrightarrow	W	W	W	mm	mm	mm	dm ³	Kg
480	500	173	100	200	470	240	120	1,89	3,72
600	500	217	123	200	470	360	120	2,38	4,58
720	500	262	145	300	470	480	120	2,87	5,45
840	500	306	167	300	470	600	120	3,36	6,32
960	500	351	189	400	470	720	120	3,85	7,19
1080	500	396	211	400	470	840	120	4,34	8,06
1200	500	440	234	400	470	960	120	4,83	8,93
1440	500	529	271	600	470	1200	120	5,81	10,67
1680	500	618	308	600	470	1440	120	6,79	12,40
1920	500	707	343	800	470	1680	120	7,78	14,14

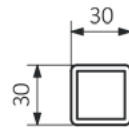
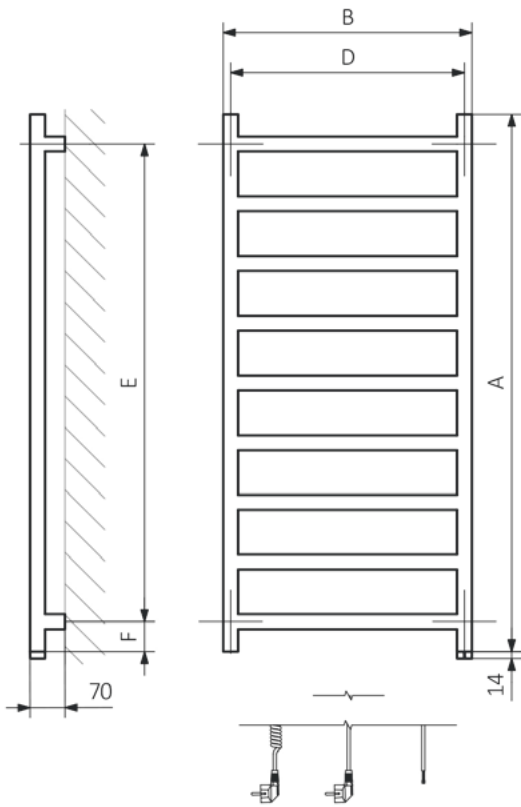
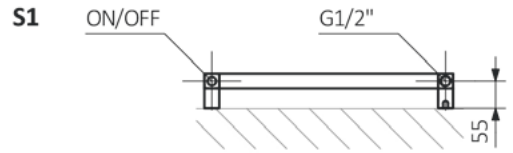
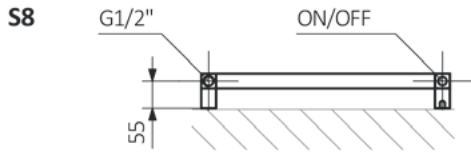



Akstyle srl

Via Italia, 121
21050 Marnate (VA)
info: +39 333 4965731
info@artekalor.it
www.artekalor.it



ARTEKALOR
K

INFO@ARTEKALOR.IT

WWW.ARTEKALOR.IT